

Assembly Layout/装配方案

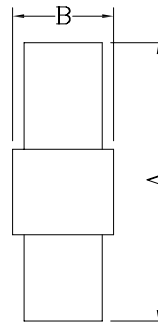

Poles 位数	Dimensions/尺寸	
	A	B
1X1	30.5	7.5
1X2	32.2	7.5
1X3	31.0	7.5
1X4	31.0	7.5
1X5	31.2	7.5
2X2	30.3	11.2
2X3	31.0	15.0
3X3	32.0	15.0
3X4	32.0	15.0
3X5	31.6	15.0

## Specifications/技术参数:

Poles/位数	1~15 Poles
Plug Diameter/插头直径	Ø1.58mm
Rated Voltage/额定电压	250V AV,DC
Rated Current/额定电流	5A (AWG #20)
Withstand Voltage/耐压值	1500V AC/minute
Contact Resistance/接触电阻	10mΩ (MAX.)
Insulation Resistance/绝缘电阻	1000MΩ (MIN.)
Temperature Range/温度范围	-25°C ~ +85°C
Applicable Wire Range/适用线径	AWG #20~#24

## 5500 SERIES Ø1.58 Plug Crimp Terminal

Features/产品特性:

\* Used in 5500 series socket(用于5500系列塑壳)

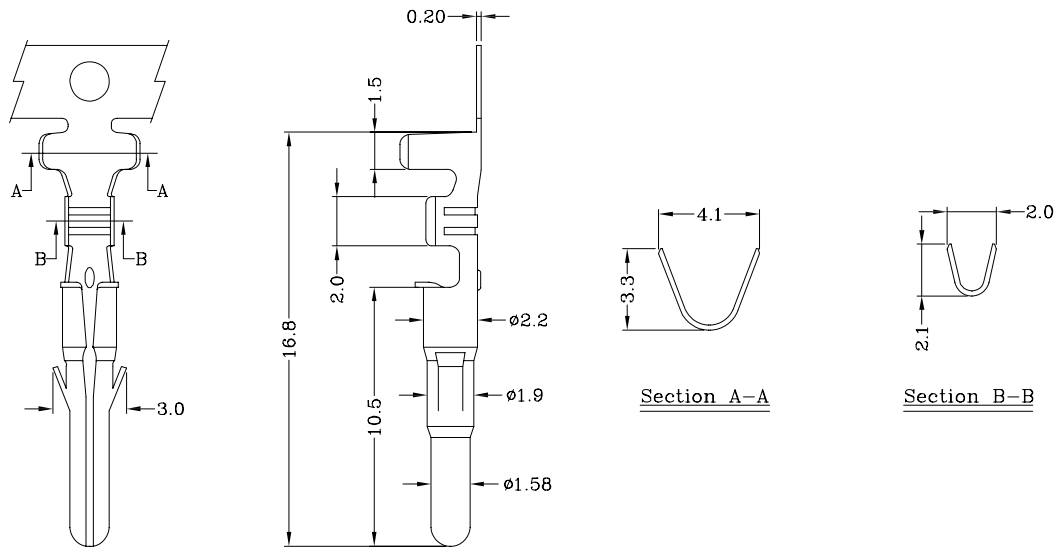

Part No./产品型号	Wire Range/线径范围	Insulation O.D/线外径	Material/材质	Finish/表面处理
5500T	AWG #20 ~ #24	3.00mm(max)	Brass	Tin-plated

## 5600 SERIES Ø1.58 Receptacle Crimp Terminal

Features/产品特性:

\* Used in 5600 series socket(用于5600系列塑壳)

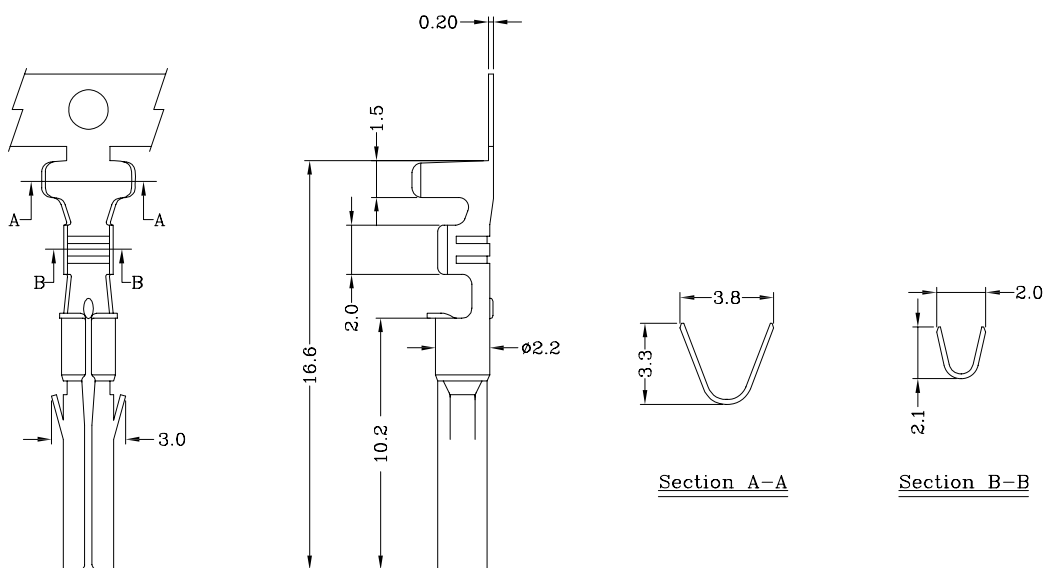

Part No./产品型号	Wire Range/线径范围	Insulation O.D/线外径	Material/材质	Finish/表面处理
5600T	AWG #20 ~ #24	3.00mm(max)	Brass	Tin-plated

Features/产品特性:

- \* Single, Dual & Triple Row Terminal Socket(单排,双排和三排端子塑壳)
- \* Material(材质): Nylon 66 UL 94V-2 (Natural)

Specification /产品说明:

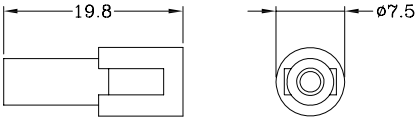
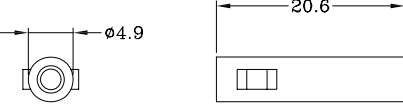
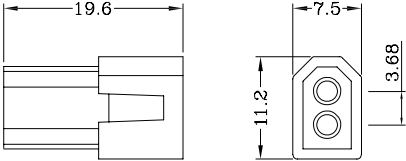
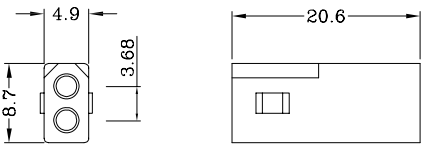
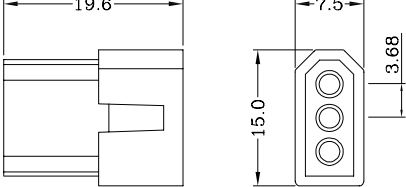
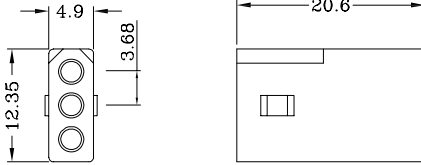
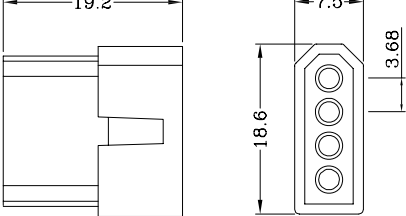
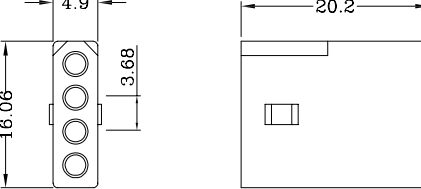
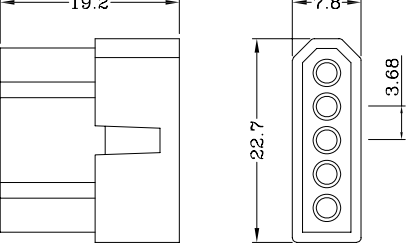
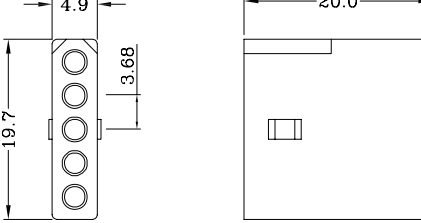
PLUG/插头	RECEPTACLE/插座
 <p style="text-align: center;"><u>5500H-1*01P</u></p>	 <p style="text-align: center;"><u>5600H-1*01P</u></p>
 <p style="text-align: center;"><u>5500H-1*02P</u></p>	 <p style="text-align: center;"><u>5600H-1*02P</u></p>
 <p style="text-align: center;"><u>5500H-1*03P</u></p>	 <p style="text-align: center;"><u>5600H-1*03P</u></p>
 <p style="text-align: center;"><u>5500H-1*04P</u></p>	 <p style="text-align: center;"><u>5600H-1*04P</u></p>
 <p style="text-align: center;"><u>5500H-1*05P</u></p>	 <p style="text-align: center;"><u>5600H-1*05P</u></p>

Specification/产品说明：

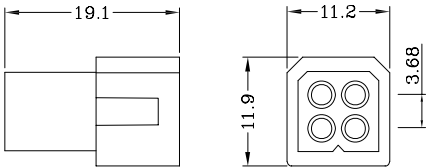
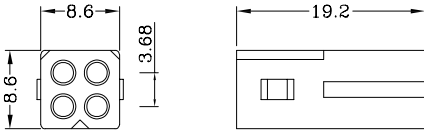
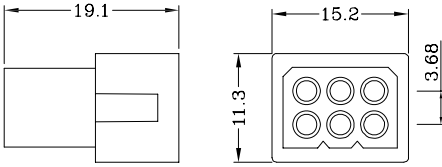
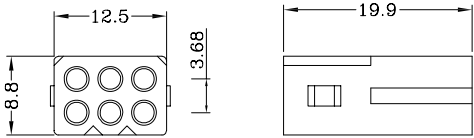
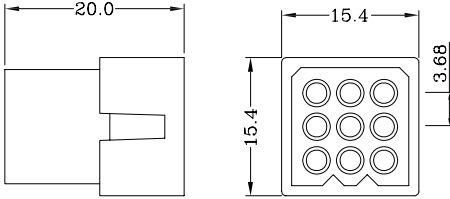
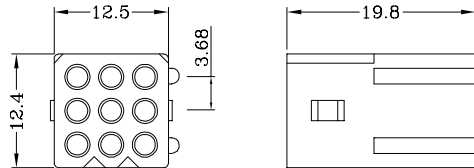
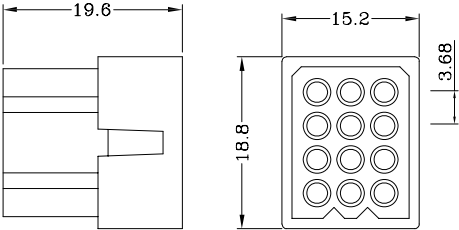
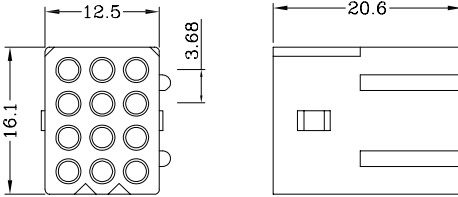
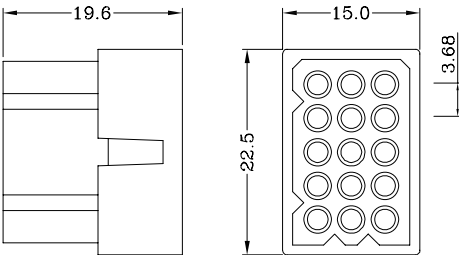
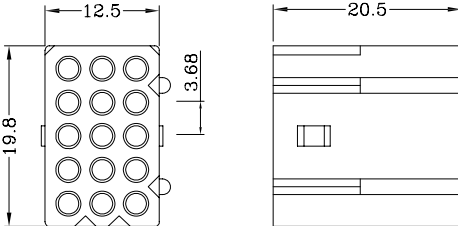
PLUG/插头	RECEPTACLE/插座
 <p data-bbox="413 568 616 600">5500H-2*02P</p>	 <p data-bbox="1059 568 1262 600">5600H-2*02P</p>
 <p data-bbox="413 887 616 918">5500H-2*03P</p>	 <p data-bbox="1059 887 1262 918">5600H-2*03P</p>
 <p data-bbox="413 1240 616 1272">5500H-3*03P</p>	 <p data-bbox="1059 1240 1262 1272">5600H-3*03P</p>
 <p data-bbox="413 1610 616 1641">5500H-3*04P</p>	 <p data-bbox="1059 1610 1262 1641">5600H-3*04P</p>
 <p data-bbox="413 1991 616 2022">5500H-3*05P</p>	 <p data-bbox="1059 1991 1262 2022">5600H-3*05P</p>