

Assembly Layout/装配方案

Poles 位数	Dim./尺寸
	A
1X2	10.4
1X3	10.4
1X4	10.4
2X2	15.2
2X3	14.9
3X3	19.4
3X4	19.4
3X5	19.4

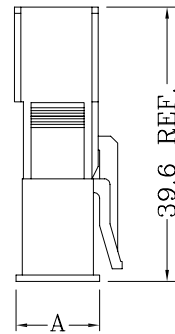

Panel Hole Layout/面板孔布局

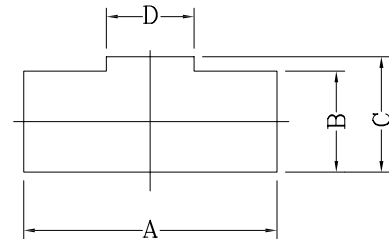

Specifications/技术参数:

Poles/位数	2~15 Poles
Plug Diameter/插头直径	Ø1.28mm
Rated Voltage/额定电压	300V AV,DC
Rated Current/额定电流	5A (AWG #20)
Withstand Voltage/耐压值	1500V AC/minute
Contact Resistance/接触电阻	7mΩ (MAX.)
Insulation Resistance/绝缘电阻	1000MΩ (MIN.)
Temperature Range/温度范围	-25°C ~ +90°C
Applicable PCB Thickness/适用板厚	0.8~2.0mm
Applicable Wire Range/适用线径	AWG #20~#26

Poles 位数	Panel Layout Dim./面板孔尺寸			
	A	B	C	D
1X2	15.0	6.0	6.85	5.2
1X3	19.7	6.0	6.85	5.2
1X4	24.2	6.0	6.85	5.2
2X2	15.6	10.6	11.60	5.2
2X3	19.7	10.2	11.10	5.2
3X3	19.7	14.8	15.70	5.2
3X4	24.2	14.8	15.70	5.2
3X5	28.7	14.8	15.70	5.2

1030 SERIES Ø1.28 Plug Crimp Terminal

Features/产品特性:

* Used in 1030 series socket(用于1030系列塑壳)

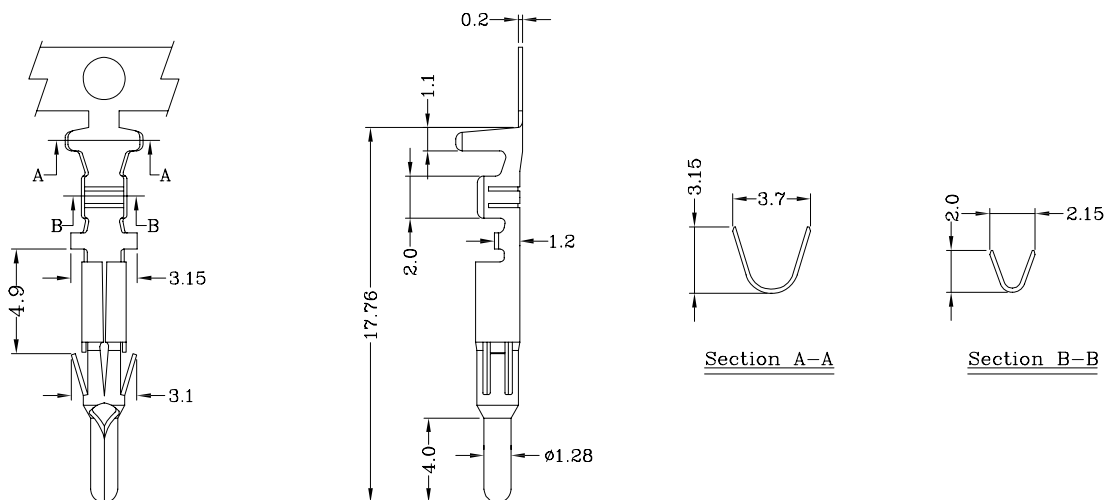

Part No./产品型号	Wire Range/线径范围	Insulation O.D/线外径	Material/材质	Finish/表面处理
1030T	AWG #20 ~ #24	2.70mm(max)	Brass	Tin-plated

1130 SERIES Ø1.28 Receptacle Crimp Terminal

Features/产品特性:

* Used in 1130 series socket(用于1130系列塑壳)

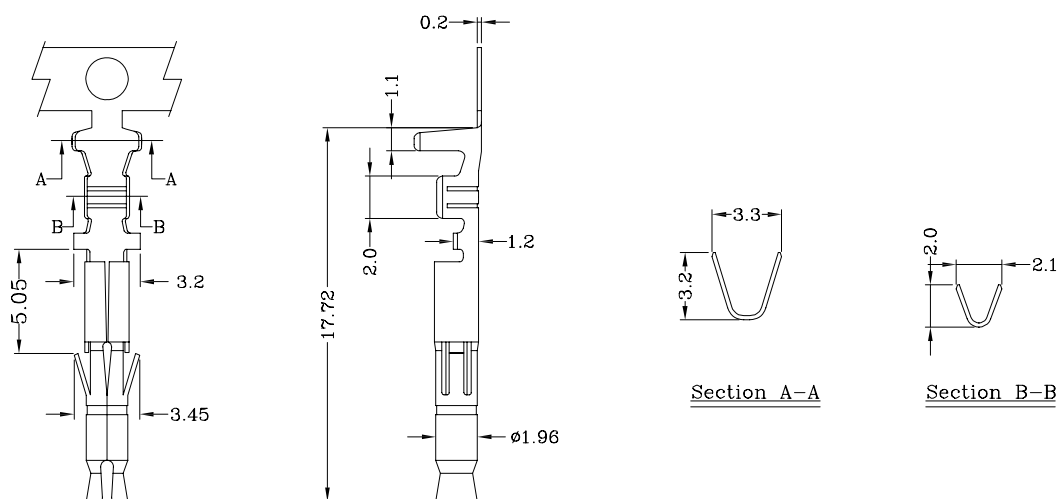

Part No./产品型号	Wire Range/线径范围	Insulation O.D/线外径	Material/材质	Finish/表面处理
1130T	AWG #20 ~ #26	2.70mm(max)	Brass	Tin-plated
1130T-P	AWG #20 ~ #26	2.70mm(max)	Phosphor bronze	Tin-plated

Features/产品特性:

- * Single, Dual & Triple Row Terminal Socket(单排, 双排和三排端子塑壳)
- * Material(材质): Nylon 66 UL 94V-2 (White)

Specification/产品说明:

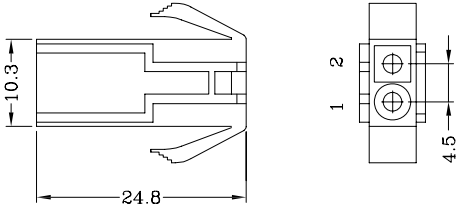
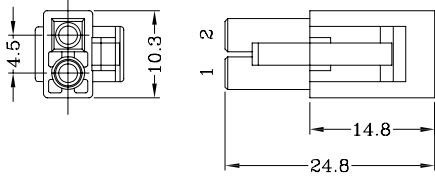
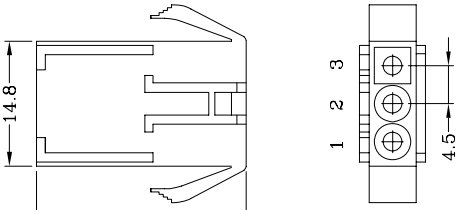
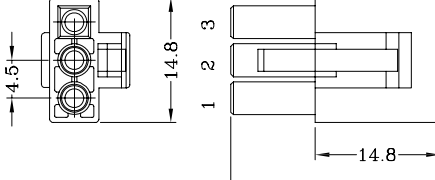
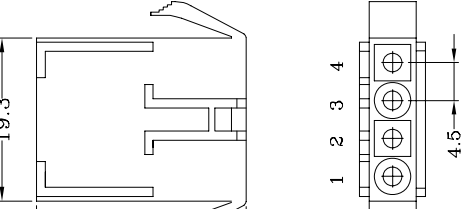
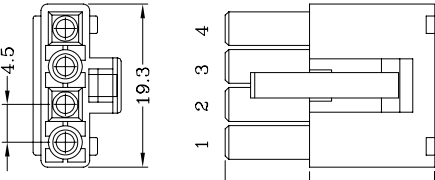
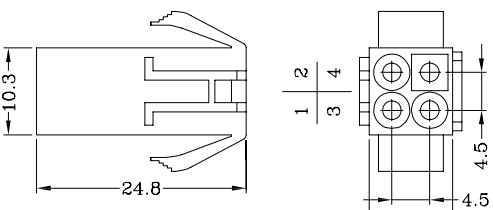
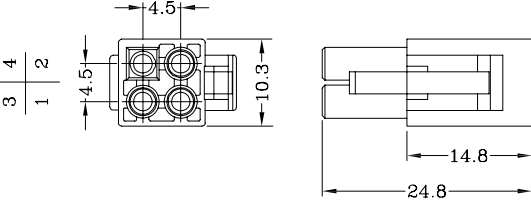
PLUG/插头	RECEPTACLE/插座
 <p style="text-align: center;"><u>1030H-1*02P</u></p>	 <p style="text-align: center;"><u>1130H-1*02P</u></p>
 <p style="text-align: center;"><u>1030H-1*03P</u></p>	 <p style="text-align: center;"><u>1130H-1*03P</u></p>
 <p style="text-align: center;"><u>1030H-1*04P</u></p>	 <p style="text-align: center;"><u>1130H-1*04P</u></p>
 <p style="text-align: center;"><u>1030H-2*02P</u></p>	 <p style="text-align: center;"><u>1130H-2*02P</u></p>

Specification/产品说明：

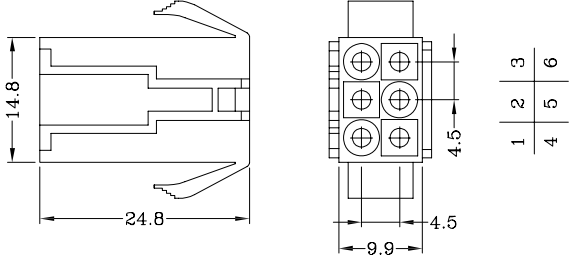
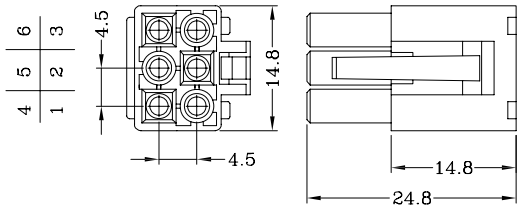
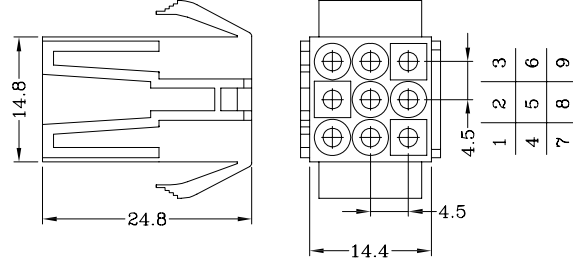
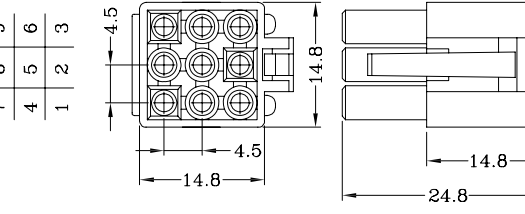
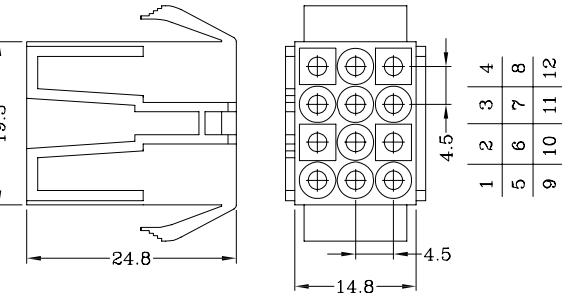
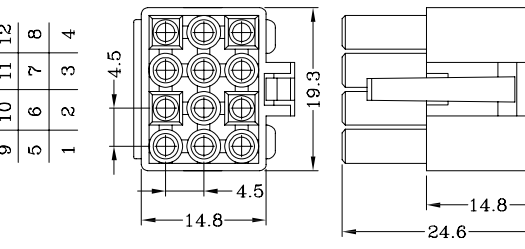
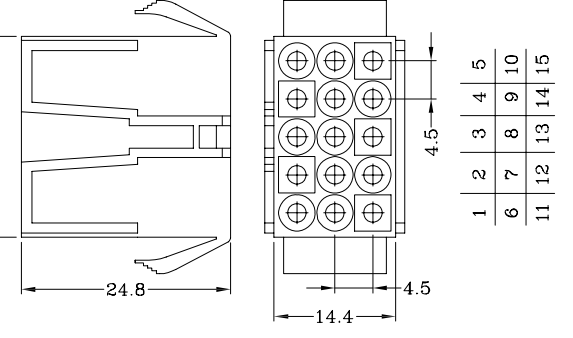
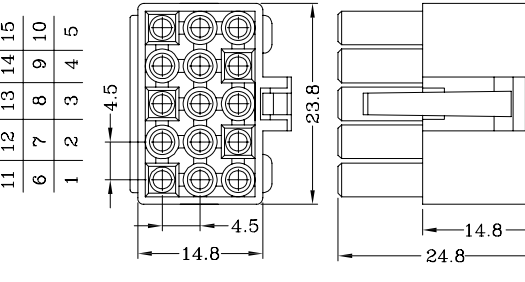
PLUG/插头	RECEPTACLE/插座
 <p style="text-align: center;"><u>1030H-2*03P</u></p>	 <p style="text-align: center;"><u>1130H-2*03P</u></p>
 <p style="text-align: center;"><u>1030H-3*03P</u></p>	 <p style="text-align: center;"><u>1130H-3*03P</u></p>
 <p style="text-align: center;"><u>1030H-3*04P</u></p>	 <p style="text-align: center;"><u>1130H-3*04P</u></p>
 <p style="text-align: center;"><u>1030H-3*05P</u></p>	 <p style="text-align: center;"><u>1130H-3*05P</u></p>