

heimatec®
黑马泰克

機械加工中心用--
高精密角度頭
„標準“系列



▶ 角度頭

360° 可轉向

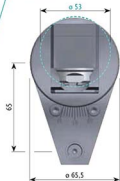
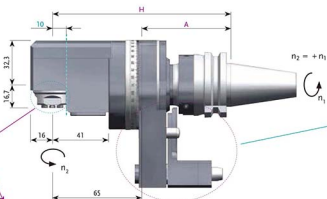
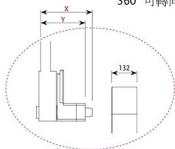

刀具應用: ER 11 A (ø0,5 - ø7,0)

旋轉 $n_{2, max}$ [1/min]: 8000

扭力 $M_{2, max}$ [Nm]: 6

冷卻劑: -

齒輪比 [i]: 1:1

旋轉方向: 相同

參考代碼	刀具/機台連結介面	中心軸 距離 H [mm]	外殼/箱體 規線 A [mm]	板手		止動塊	
					參數 X [mm]		參數 Y [mm]
7 033 23 002		130	65	✓	59	51	✓
7 033 23 001				✓	59	51	✗
7 033 23 000				✗	-	-	✗
7 033 33 002		138	73	✓	59	51	✓
7 033 33 001				✓	59	51	✗
7 033 33 000				✗	-	-	✗
7 033 23 005		130	65	✓	59	51	✓
7 033 23 004				✓	59	51	✗
7 033 23 003				✗	-	-	✗

可另加購支撐法蘭

✗ - 不包含在運送內
 ✓ - 包含在運送內
 參數 X = 底副固定螺絲規格基準線
 參數 Y = 固定副規格基準線

▶ 其他需求請另外詢問

▶ 角度頭

360° 可轉向

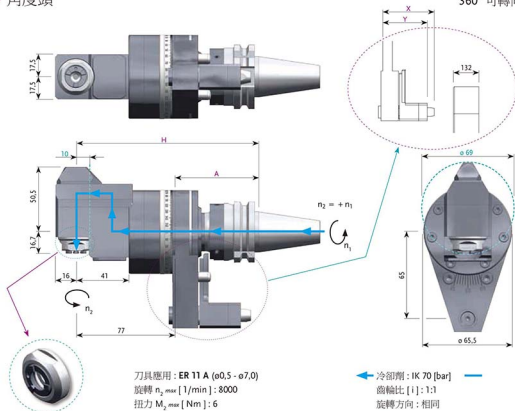

刀具應用: ER 11 A (ø0.5 - ø7.0)



旋轉 n_2 max [1/min]: 8000

扭力 M_2 max [Nm]: 6

冷卻劑: IK 70 [bar]

齒輪比 [i]: 1:1

旋轉方向: 相同

參考代碼	刀座/機台連結介面	中心軸距離 H [mm]	外觀/箱體規線 A [mm]	扳手			止動塊
					參數 X [mm]	參數 Y [mm]	
7 033 23 008		142	65	✓	59	51	✓
7 033 23 007				✓	59	51	✗
7 033 23 006				✗	-	-	✗
7 033 33 005		150	73	✓	59	51	✓
7 033 33 004				✓	59	51	✗
7 033 33 003				✗	-	-	✗
7 033 23 011		142	65	✓	59	51	✓
7 033 23 010				✓	59	51	✗
7 033 23 009				✗	-	-	✗

可另加購支撐法蘭

✓ = 不包含在運送內
 ✗ = 包含在運送內
 參數 X = 底面固定螺絲間標準距離
 參數 Y = 固定器箱體標準距離

▶ 其他需求請另外詢問

▶ 角度頭 + 90°

360° 可轉向

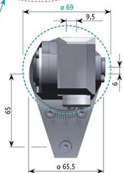
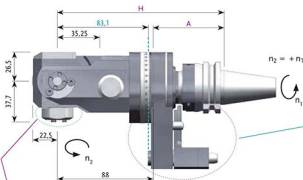
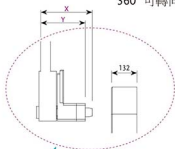

刀具應用: ER 11 A (ø0,5 - ø7,0)

旋轉 $n_{2, max}$ [1/min]: 8000

扭力 $M_{2, max}$ [Nm]: 5

冷卻劑: -

齒輪比 [i]: 1:1

旋轉方向: 相同

參考代碼	刀座/機台連結介面	中心軸距離 H [mm]	外殼/箱體規線 A [mm]	板手		止動塊
				參數 X [mm]	參數 Y [mm]	
7 043 23 008		153	65		✓	✓
7 043 23 007				✓	✗	
7 043 23 006				✗	✗	
7 043 33 002		161	73		✓	✓
7 043 33 001				✓	✗	
7 043 33 000				✗	✗	
7 043 23 003		153	65		✓	✓
7 043 23 000				✓	✗	
7 043 23 002				✗	✗	

可另加購支撐法蘭

✗ - 不包含在運送內
 ✓ - 包含在運送內
 參數 X = 底面固定螺絲規格標準值
 參數 Y = 頂面固定螺絲規格標準值

▶ 其他需求請另外詢問

▶ 角度頭 + 90°

360° 可轉向

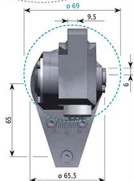
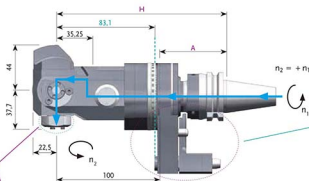
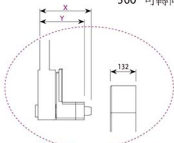

刀具應用: ER 11 A (ø0.5 - ø7.0)

 旋轉 n_2 max [1/min]: 6000

 扭力 M_2 max [Nm]: 5

冷卻劑: 1K 70 [bar]

齒輪比 [i]: 1:1

旋轉方向: 相同

參考代碼	刀座/機台連結介面	中心軸距離 H [mm]	外觀/箱體 規線 A [mm]	扳手			止動塊
					參數 X [mm]	參數 Y [mm]	
7 043 23 011	 DIN 69871 A - SK 30	165	65	✓	59	51	✓
7 043 23 010				✓	59	51	✗
7 043 23 009				✗	-	-	✗
7 043 33 005	 DIN 69893 - HSK 40 A	173	73	✓	59	51	✓
7 043 33 004				✓	59	51	✗
7 043 33 003				✗	-	-	✗
7 043 23 005	 MAS 403 BT 30	165	65	✓	59	51	✓
7 043 23 001				✓	59	51	✗
7 043 23 004				✗	-	-	✗

可另加購支撐法蘭

 ✗ 不包含在運送內
 ✓ 包含在運送內
 參數 X = 底面固定螺絲規格基準值
 參數 Y = 固定器規格基準值

▶ 其他需求請另外詢問

heimatec®

● heimatec® - 海外分公司與辦事處

● heimatec® - 全球代理商

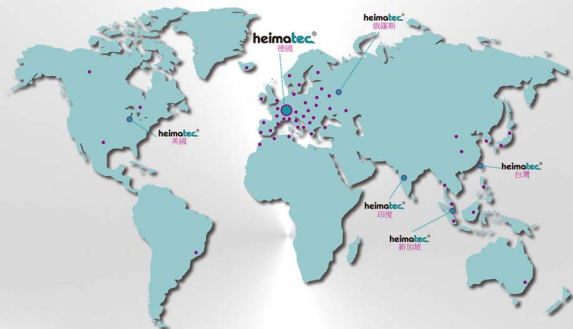

苏州迈道纳自动化科技有限公司

Suzhou Madaula Automation Technology Co.Ltd

地址：苏州市相城经济开发区澄阳路

116号阳澄湖国际科创园1号楼716室

716 1# Building chengYang Rd No.116 Xiangcheng
Zone, Suzhou

Tel:0512-6759 1716

Email:info@cuttool.cn

www.madaula.net